



**Electrolux**  
PROFESSIONAL

## Stainless Steel Preparation 373x834 mm Aluminum Corner Unit

ITEM # \_\_\_\_\_

MODEL # \_\_\_\_\_

NAME # \_\_\_\_\_

SIS # \_\_\_\_\_

AIA # \_\_\_\_\_



137051 (ACS830)

Corner Shelving Set with  
aluminium side uprights and  
4 polyethylene louvered  
shelves, 373x834 mm

### Short Form Specification

Item No. \_\_\_\_\_

For corner installation. 4-level shelving set with louvered sectional polyethylene shelves (depth=373mm). Aluminium (20 micron) side uprights (height=1700mm). Adjustable feet. To be combined with a linear shelving unit

### Main Features

- Complete shelving system allows rapid and easy fixing of the shelves to the uprights.
- GN 1/1, GN 1/2 and GN 1/3 can be inserted into the frame.

### Construction

- Uprights and shelf frames constructed entirely in anodized aluminium (20 micron).
- Shelves made by section of polyethylene tablets.
- Sectional polyethylene shelves are dishwasher safe.
- Corner shelving must be fixed to a linear shelf (either 375mm or 475mm in depth) with the included bar clamps and can be positioned anywhere along the length of the linear shelf.
- 4 tiers and 4 corner clamps.

### Optional Accessories

- Polyethylene shelf with aluminium frame, 373x798mm PNC 850038
- Angle joint for shelves (depth=373mm) PNC 850070
- 2 swivelling wheels, 100mm PNC 850072
- 2 swivelling wheels with brakes, 100mm PNC 850073

APPROVAL: \_\_\_\_\_



Experience the Excellence  
[www.electroluxprofessional.com](http://www.electroluxprofessional.com)

Front

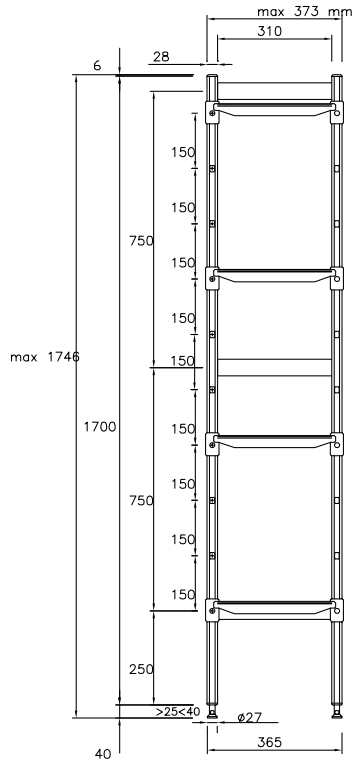

Top

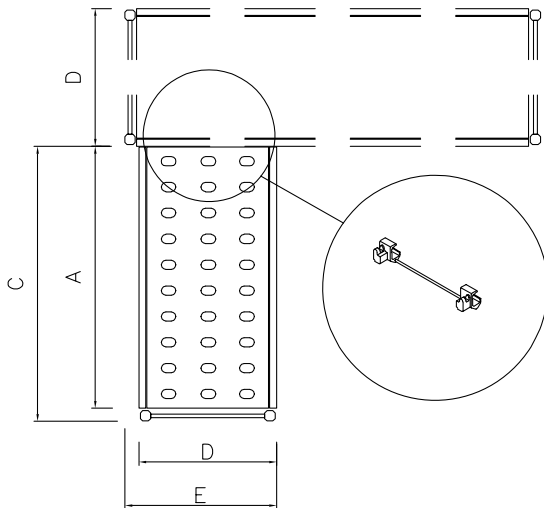

Other

	A mm	C mm	D mm	E mm
137050	708	744	373	407
137051	798	834	373	407
137052	886	922	373	407
137053	974	1010	373	407
137054	1062	1098	373	407
137055	1152	1188	373	407
137056	1240	1276	373	407
137057	1330	1366	373	407
137058	1505	1541	373	407

**Key Information:**
**Uprights**

137051 (ACS830) 1

**External dimensions, Width:** 834 mm

**External dimensions, Depth:** 373 mm

**External dimensions, Height:** 1700 mm

**Max loading weight:** 1000 kg

**Net weight:** 14 kg